



M16 Thermal – Professional Thermographic Camera

■ Intelligentes MOBOTIX Videosystem mit Hochleistungswärmebildsensor

Thermal sensitivity 50 mK, thermal radiometry, image overlay, temperature detection range -40 to 550°C

■ Dual Lens System: Thermographic And Detailed Optical Images At The Same Time

One factory-assembled thermal sensor, optionally with second optical sensor module (Day, Night, Night-LPF)

■ Powerful, Intelligent And Flexible Mx6 System Platform

Simultaneous streaming of up to three video codecs (MxPEG, MJPEG and H.264)

■ Intelligent 3D Motion Detection Even On Complete Darkness

MxActivitySensor integrated as standard also for thermal sensor

■ Reduced Energy Costs

Power consumption < 7 W, standard PoE

■ Virtually Maintenance-Free

Weatherproof, IP66, -30 to 60°C



General Product Information

Basic Information On Thermal Imaging Technology

Thermal imaging technology is a contactless imaging procedure that makes it possible to see the thermal radiation from an object or body otherwise invisible to the human eye (mid-wavelength infrared). Thermal radiation is electromagnetic radiation emitted by a body based on its temperature. It is caused by thermal motion within a body's molecules. This is the result of accelerated charges that emit radiation in accordance with the laws of electrodynamics. Thermal imaging technology captures and displays temperature distribution across surfaces and objects. Thermographic cameras usually display heat intensity information in artificial colors (blue = cooler, red = warmer). In terms of the number of pixels, the resolution is considerably lower than that for cameras capturing the visible spectral range.

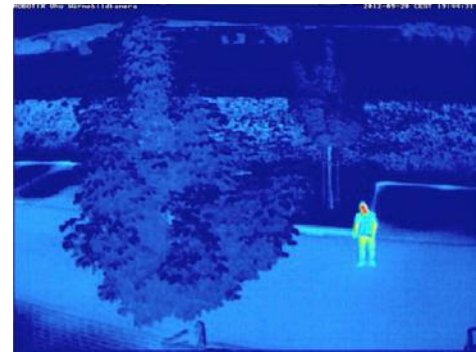

Unlike cameras with optical image sensors, one of the decisive quality criteria for a thermal camera is the camera's ability to capture the slightest differences in temperature and to produce an image that displays these differences in colors. The NETD, or Noise Equivalent Temperature Difference, is used to measure the sensitivity of a thermal sensor and is expressed in millikelvin. With an NETD of 50 mK, MOBOTIX thermal cameras can visualize temperature variations starting at 0.05°C, which places them in the top range of cameras currently available for general use.

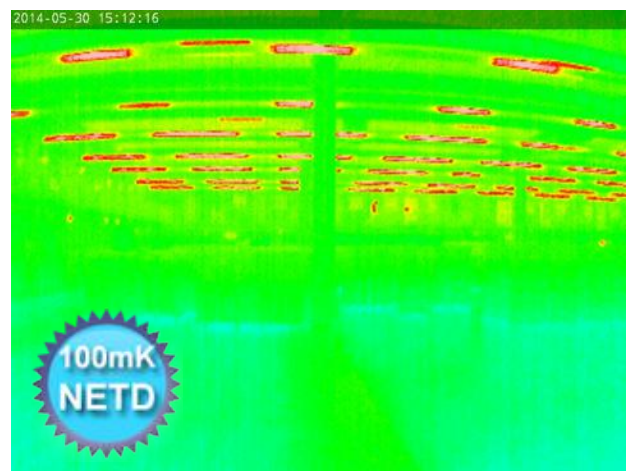
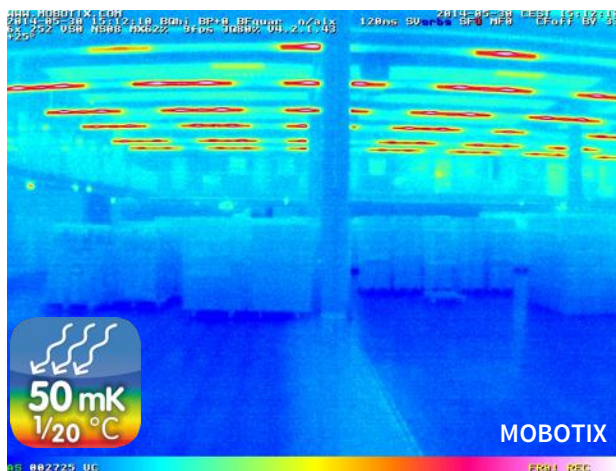

Thanks to an NETD of 50 mK, the MOBOTIX thermal image (left) shows significantly more details than a competitor's less powerful thermographic camera with an NETD of 100 mK (right).

Respecting Privacy

The detected thermal profile of a thermal camera shows no identifiable details for identification of persons and can therefore guarantee privacy. As soon as an object is moving into the relevant surveillance area, MOBOTIX dual camera system can automatically switch from thermal sensor to the optical sensor, producing visible high

Technical Specifications

MOBOTIX M16 Thermal



resolution video. This unique MOBOTIX feature combines two aspects, respecting the privacy aspect and at the same time optimal video surveillance.

Temperature Events And Thermal Overlay

Thermal radiometry (TR) cameras from MOBOTIX generate automatic alarms, defined by temperature limits or temperature ranges, which is vital to detect potential fire or heat sources. Up to 20 different temperature triggers can be defined at the same time within so-called TR (Thermal Radiometry) windows or the whole sensor image can be used over the temperature range of -40 to +550 °C. In this way critical situations can be analyzed in the control room in order to plan the next steps for effective fire prevention. Critical assets like emergency generators, wind turbines or radio stations can be cost-effectively maintained and tested remotely. MOBOTIX thermal dual camera systems offer thermal overlay to localize so-called hot spots in the visual image to prevent larger damage. The standard Power-over-Ethernet (PoE) compatibility and the extremely low power consumption of only 6 watts allows operation of MOBOTIX thermal camera systems in every situation.

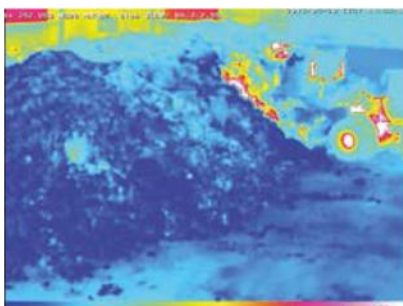

Fire prevention



No smoking area



Thermal image overlay

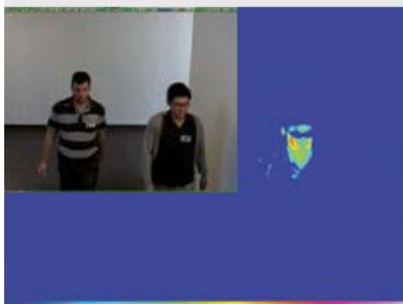

Border control

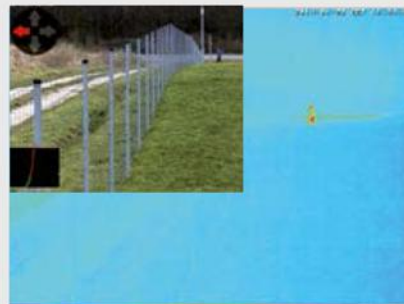

Perimeter protection



Privacy zones

PLEASE NOTE – Special Export Regulations For Thermographic Cameras

Cameras with thermographic image sensors (“thermographic cameras”) are subject to special U.S. and ITAR (International Traffic in Arms Regulation) export regulations:

According to currently valid export regulations from the U.S. and ITAR, cameras with thermographic image sensors or their component parts cannot be exported to countries that have been embargoed by the U.S./ITAR. The corresponding delivery ban also applies to all individuals and institutions included on “The Denied Persons List” (see www.bis.doc.gov under Policy Guidance > Lists of Parties of Concern). These cameras and their installed thermographic image sensors are not to be used for the design, development, or production of nuclear, biological or chemical weapons or installed in these systems.

For further informations visit the MOBOTIX website: www.mobotix.com/other/Partners/Thermal

Technical Specifications

MOBOTIX M16 Thermal



Camera Variants	M16 Thermal	M16 Thermal TR
Specialties	IP Thermographic camera with/without Thermal Radiometry technology (TR) and Germanium lens (3 different image angles available); can be optionally equipped with a second optical 6MP sensor module (day/color or night/black and white to be ordered separately for easy self-assembly)	
Main Differences	Temperature measurement only in the center of the image (Thermal Spot, 2x2 pixels), accuracy up to +/- 20°C	TR temperature measurement of each pixel in the whole image area, up to 20 independant temperature events, accuracy up to +/- 10°C
Thermal Lenses/Sensors, 50 mK, 336 x 252 (Factory-Assembled)	M16 Thermal	M16 Thermal TR
Thermal sensor, horiz./vert. image angle 45°/32	Mx-M16TA-T079	-
Thermal sensor, horiz./vert. image angle 25°/19°	Mx-M16TA-T119	-
Thermal sensor, horiz./vert. image angle 17°/13°	Mx-M16TA-T237	-
Calibrated Thermal sensor TR/Thermal Radiometry, horiz./vert. image angle 45°/32	-	Mx-M16TA-R079
Calibrated Thermal sensor TR/Thermal Radiometry, horiz./vert. image angle 25°/19°	-	Mx-M16TA-R119
Calibrated Thermal sensor TR/Thermal Radiometry, horiz./vert. image angle 17°/13°	-	Mx-M16TA-R237
Thermal image sensor	Uncooled microbolometer with 336 x 252 pixels, IR range 7,5 to 13,5 µm	
Sensitivity NETD (thermal resolution)	Typ. 50 mK, < 79 mK (50 mK is equal to temperature changes of 0,05°C)	
Thermal image representation	False colors or black and white	
Temperature measuring range (adjustable)	High Sensitivity: -40 to 160°C – Low Sensitivity: -40 to 550°C	
Temperature measuring method (via camera)	In the center of the image (2x2 pixels)	Complete image areas (customizable temperature measurement windows)
Max. accuracy of temperature measurement	+/- 20°C	+/- 10°C
Optical Lenses/Sensors, 6MP, 3072 x 2048 (Available With Optional Sensor Module)	M16 Thermal	M16 Thermal TR
Sensor module with Fisheye Lens B016 (180° x 180°), night version optionally with long-pass filter (LPF)	Day/Color: Mx-O-SMA-S-6D016 Night/Black&White: Mx-O-SMA-S-6N016 LPF/Black&White: Mx-O-SMA-S-6L016	
Sensor module with Ultra Wide Lens B036 (103° x 77°), night version optionally with LPF	Day/Color: Mx-O-SMA-S-6D036 Night/Black&White: Mx-O-SMA-S-6N036 LPF/Black&White: Mx-O-SMA-S-6L036	
Sensor module with Super Wide Lens B041 (90° x 67°), night version optionally with LPF	Day/Color: Mx-O-SMA-S-6D041 Night/Black&White: Mx-O-SMA-S-6N041 LPF/Black&White: Mx-O-SMA-S-6L041	
Sensor module with Wide Lens B061 (60° x 45°), night version optionally with LPF	Day/Color: Mx-O-SMA-S-6D061 Night/Black&White: Mx-O-SMA-S-6N061 LPF/Black&White: Mx-O-SMA-S-6L061	
Sensor module with Standard Lens B079 (45° x 34°), night version optionally with LPF	Day/Color: Mx-O-SMA-S-6D079 Night/Black&White: Mx-O-SMA-S-6N079 LPF/Black&White: Mx-O-SMA-S-6L079	
Sensor module with Tele Lens B119 (31° x 23°), night version optionally with LPF	Day/Color: Mx-O-SMA-S-6D119 Night/Black&White: Mx-O-SMA-S-6N119 LPF/Black&White: Mx-O-SMA-S-6L119	
Sensor module with Distant Tele Lens B237 (15° x 11°), night version optionally with LPF	Day/Color: Mx-O-SMA-S-6D237 Night/Black&White: Mx-O-SMA-S-6N237 LPF/Black&White: Mx-O-SMA-S-6L237	

Technical Specifications

MOBOTIX M16 Thermal



Optical Lenses/Sensors, 6MP, 3072 x 2048 (Available With Optional Sensor Module)	M16 Thermal	M16 Thermal TR
Sensor module with Super Tele Lens B500 (8° x 6°), night version optionally with LPF	Day/Color: Mx-O-SMA-S-6D500 Night/Black&White: Mx-O-SMA-S-6N500 LPF/Black&White: Mx-O-SMA-S-6L500	
Sensor module with CS-Mount (no lens included)	Day/Color: Mx-O-SMA-S-6DCS Night/Black&White: Mx-O-SMA-S-6NCS	
Sensor module with CSVario Lens B045-100-CS	Day/Color: Mx-O-SMA-S-6DCSV Night/Black&White: Mx-O-SMA-S-6NCSV	
Image sensor with individual exposure zones	1/1.8" CMOS, 6MP (3072 x 2048), Progressive Scan Color or Black And White	
Light sensitivity in lux at 1/60 s and 1/1 s	Color Sensor: 0,1/0,005 Black And White Sensor: 0,02/0,001	
Hardware	M16 Thermal	M16 Thermal TR
Microprocessor	i.MX 6 Dual Core incl. GPU (1 GB RAM, 512 MB Flash)	
H.264 Hardware-Codec	Yes, bandwidth limitation available; output image format up to QXGA	
Protection class	IP66 and IK06; with second 6MP sensor module: IK04 with B036 to B237, IK06 with B016	
Intended use	Not for use in hazardous areas (Ex area); no mounting behind glass windows	
Ambient temperature (range, incl. storage)	-30 to 60°C/-22 to 140°F	
Internal DVR, ex works	4 GB (microSD)	
Microphone/speaker	Yes/Yes	
16bit/16kHz HD wideband audio (Opus codec)	Yes (live and audio messages)	
Passive infrared sensor (PIR)	Yes	
Temperature sensor	Yes	
Shock detector (tamper detection)	Yes (with future software update)	
Power consumption	Single thermal operation (1x thermal): typ. 5.5 W (6.5 W possible over the short term) Mixed operation (1x thermal, 1x optical): typ. 6.5 W (7.5 W possible over the short term)	
PoE class (IEEE 802.3af)	Class 2 or 3 (variable), factory setting: class 3 (required for thermal operation)	
Interfaces Ethernet 100BaseT/MxBus/USB	Yes (MxRJ45)/No/Yes	
Interface RS232	With accessory (MX-232-IO-Box)	
Mounting options	Wall, pole or ceiling (wall and ceiling mount included)	
Dimensions (height x width x depth)	210 x 158 x 207 mm	
Weight	1,320 g	
Housing	PBT-30GF, color: white	
Standard accessory	Screws, dowels, screw caps, 2 allen wrenches, module key, VarioFlex wall and ceiling mount with rubber sealing, 0.5 m ethernet patch cable, 1 blind module, Quick Install	
Detailed technical documentation	www.mobotix.com > Support > Manuals	
Online version of this document	www.mobotix.com > Support > Spec Sheets	
MTBF	> 80,000 hours	
Certifications	EN55032:2012 EN55022:2010; EN55024:2010 EN61000-6-1:2007; EN 61000-6-2:2005 EN61000-6-3:2007+A1:2011 EN61000-6-4:2007+A1:2011 AS/ NZS CISPR22:2009+A1:2010 CFR47 FCC part15B	
Protocols	IPv4, IPv6, HTTP, HTTPS, FTP, SFTP, RTP, RTSP, UDP, SNMP, SMTP, DHCP (client and server), NTP (client and server), SIP (client and server) G.711 (PCMA and PCMU) and G.722	

Technical Specifications

MOBOTIX M16 Thermal



Image Formats, Frame Rates, Image Storage	M16 Thermal	M16 Thermal TR
Available video codecs	MxPEG/MJPEG/H.264	
Image formats	Freely configurable format 4:3, 8:3, 16:9 or customized format (Image Cropping), such as 2592x1944 (5MP), 2048x1536 (QXGA), 1920x1080 (Full-HD), 1280x960 (MEGA)	
Multistreaming	Yes	
Multicast stream via RTSP	Yes	
Max. image format (dual image from both sensors)	2x 6MP (6144 x 2048)	
Max. frame rate for thermal images, Thermal Overlay and dual images (thermal & optical)	9 frames per second (fps)	
Max. frame rate for optional optical 6MP sensor module (fps, only single core used)	MxPEG: 42@HD(1280x720), 34@Full-HD, 24@QXGA, 15@5MP, 12@6MP, 6@2x 6MP MJPEG: 26@HD(1280x720), 13@Full-HD, 9@QXGA, 5@5MP, 4@6MP, 2@2x 6MP H.264: 25@Full-HD, 20@QXGA	
Number of images with 4 GB microSD (internal DVR)	CIF: 250,000, VGA: 125,000, HD: 40,000, QXGA: 20,000, 6MP: 10,000	
General Functions	M16 Thermal	M16 Thermal TR
Temperature measurement of 2x2 pixels in the center of the image (Thermal Spot)	Yes	Yes
TR temperature measurement in the whole image area	No	Yes
Event trigger for temperatures above or below a limit between -40 to 550°C/-40 to 1022°F	Yes	Yes
Digital zoom and pan	Yes	
ONVIF compatibility	Yes, complete ONVIF Profile S supported by future software update	
Genetec protocol integration	Yes	
Programmable exposure zones	Yes	
Snapshot recording (pre/post-alarm images)	Yes	
Continuous recording with audio	Yes	
Event recording with audio	Yes	
Time controlled flexible event logic	Yes	
Weekly schedules for recordings and actions	Yes	
Event video and image transfer via FTP and email	Yes	
Playback and QuadView via web browser	Yes	
Bidirectional audio in browser	Yes	
Animated logos on the image	Yes	
Master/Slave functionality	Yes	
Privacy zone scheduling	Yes	
Customized voice messages	Yes	
VoIP telephony (audio/video, alert)	Yes	
Remote alarm notification (network message)	Yes	
Programming interface (HTTP-API)	Yes	
DVR/Storage Management	Inside camera via microSD card, externally via USB device and NAS, different streams for live image and recording, MxFFS with archive function, pre-alarm and post-alarm images, monitoring recording with failure reporting	
Camera and data security	User and group management, SSL connections, IP-based access control, IEEE802.1x, intrusion detection, digital image signature	

Technical Specifications

MOBOTIX M16 Thermal



General Functions	M16 Thermal		M16 Thermal TR
MxMessageSystem: Sending and receiving of MxMessages	Yes		
Video Analysis	M16 Day	M16 Night	M16 Day & Night
Video motion detector	Yes		
MxActivitySensor	Yes		
Video Management Software	M16 Day	M16 Night	M16 Day & Night
MxManagementCenter	Yes		
Mobile MOBOTIX App	Yes		

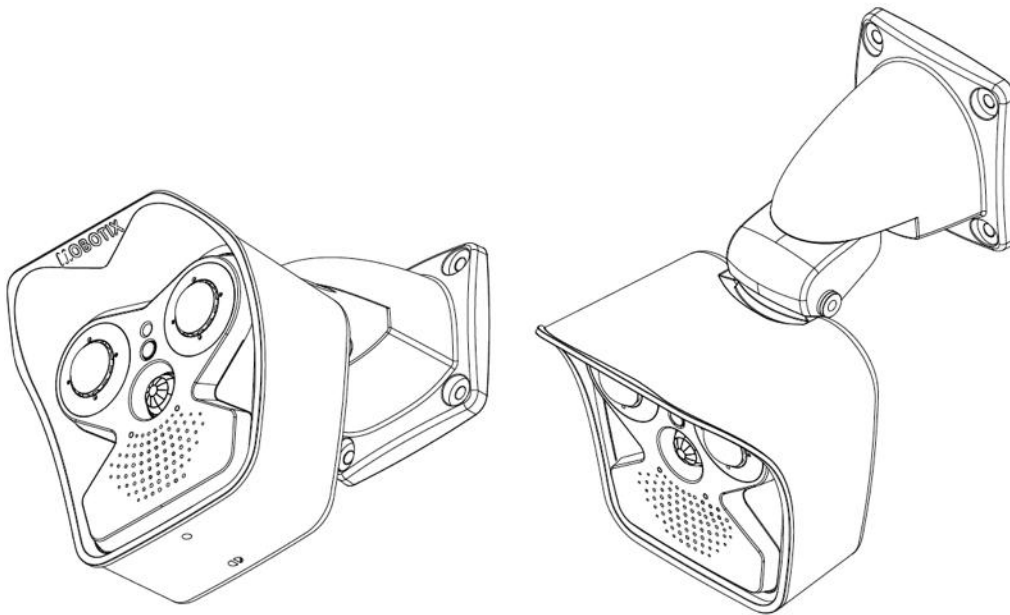

Technical Specifications

MOBOTIX M16 Thermal

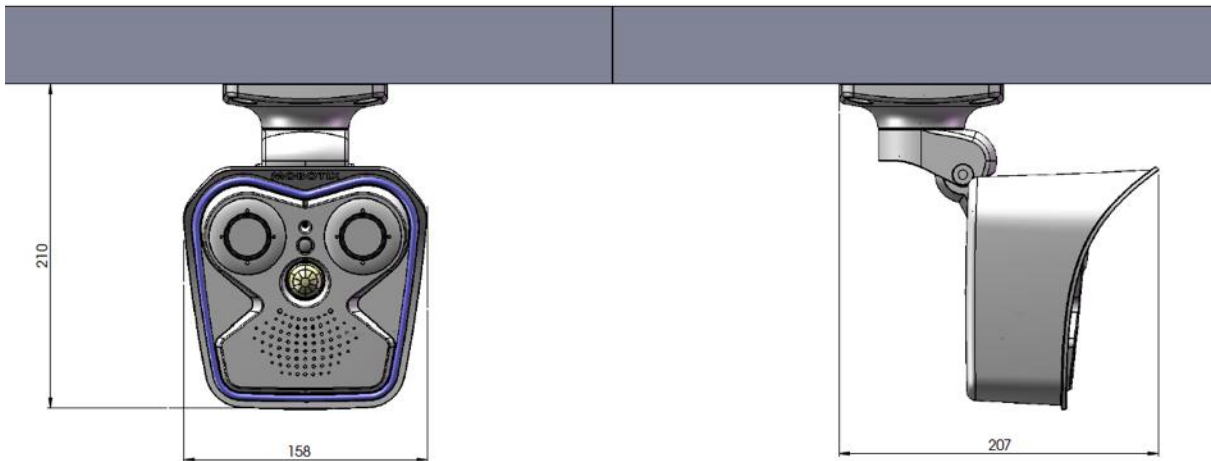
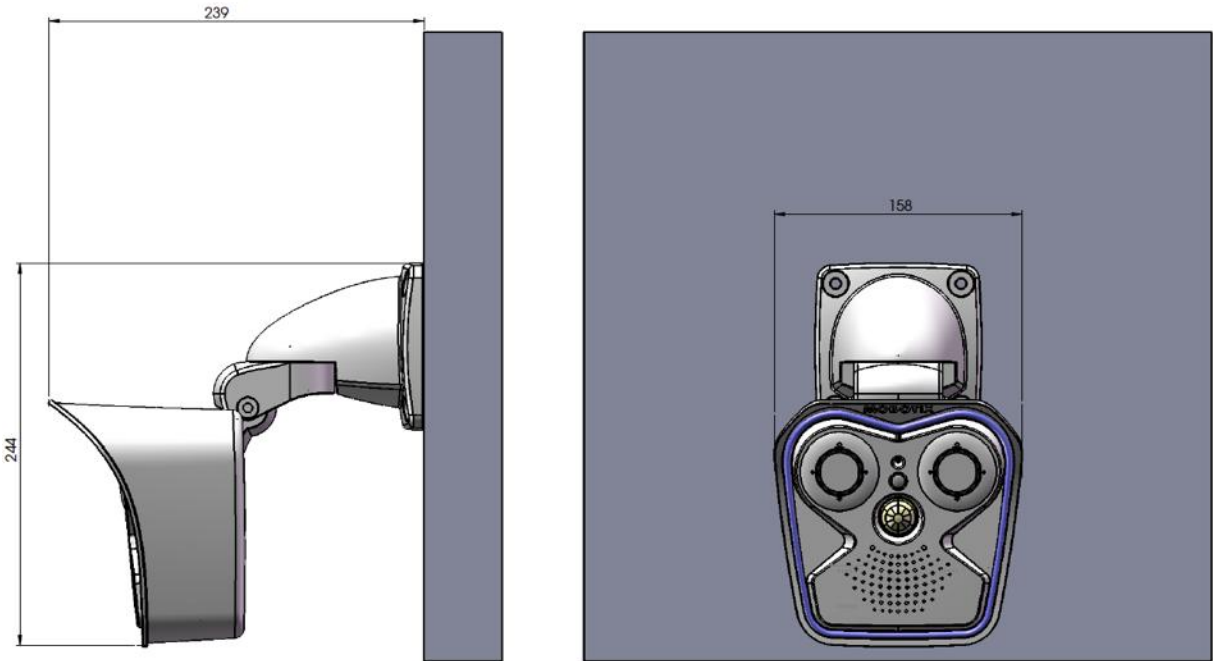

Dimensions in mm

